

INSTALLATION GUIDE

ER8500C

8 Port IP Video Extender Over Coax With Built-In Gigabit PoE Switch

*EtherStretch*TM



Description

The ER8500C is another component of NITEK's cutting edge *EtherStretch* line. Our *Etherstretch* solution allows for the utilization of existing cable infrastructure (coax or UTP) to transmit data from IP cameras and other network devices along with power (PoE & PoE+) to operate these networked devices over the given wire media well over the 100m/328ft networking distance limitation.

The ER8500C is a rack mounted eight (8) port power sourcing receiver unit with built-in gigabit switching capabilities. The unit requires very little installation time and absolutely no set up or configuration. The ER8500C and associated ET1500C transmitters (up to 8) can quickly turn ordinary RG59 coax cables into a series of high speed network communication and PoE pathways.

The ER8500C is completely transparent to the network thus requiring no IP and MAC addressing. Simply connect your network devices to the transmitter LAN ports along with the existing cables to the receiver and the system quickly begins communicating. LED indicators show the status and data speed of network communications along with PoE power confirmation.

NITEK's *EtherStretch* ER8500C reliably extends network communications to overcome cable distance limitations offering connectivity to devices in locations traditional networking does not allow. The ER8500C is ideal for retro-fitting existing installations. The rack mounted unit is robustly constructed of molded steel casing with appropriate built in cooling and ventilation.

NITEK[®]

USA

5410 Newport Drive, # 24
Rolling Meadows, IL 60008
Phone: (847) 259-8900
Fax: (847) 259-1300
E-mail: info@nitek.net
WWW.NITEK.NET

EUROPE

De Schans 19-21 2a
8231 KA Lelystad
Tel: +31(0)320-2300005
Fax: +31(0)320-282186
E-mail: info@nitek.nl
WWW.NITEK.NL

Important Safety Instructions

Be sure to read these Safety Instructions.

Keep the Instructions for future reference.

Be sure to HEED all Warnings.

Follow ALL instructions.

DO NOT use this device or any of the equipment described, near water.

Clean this device ONLY with a dry cloth.

DO NOT block any ventilation openings.

Install in accordance with the manufacturer's instructions.

DO NOT install near any heat sources such as radiators, heat registers, stoves or other apparatus (including amplifiers) that produce heat.

DO NOT defeat the safety purposes of polarized or grounding type plugs. A polarized plug has two blades, with one blade wider than the other. A grounding plug has two blades and has a third grounding prong. The wide blade and the grounding prong are provided for your safety. If the provided plug does not fit into your outlet, consult an electrician for replacement of the obsolete outlet.

Protect the power cord from being walked on or pinched especially at plugs, convenience receptacles and other points where they exit from the device.

Only use attachments and/or accessories specified by the manufacturer.

Refer all servicing to qualified service personnel. Servicing is required when the device has been damaged in any way, such as the power supply cord or plug is damaged, liquid has been spilled on, or objects have fallen into the device, the device has been exposed to rain or moisture, does not operate normally or has been dropped.

WARNING: To reduce risk of fire or electric shock, do not expose this apparatus to rain or moisture.

Installation shall be performed ONLY by qualified personnel and must conform to all local codes.

Unless the device is specifically marked as a NEMA 3, 3R, 3S, 4, 4X, 6 or 6P enclosure, it is designed for indoor use ONLY and it must not be installed where exposed to rain or moisture.

Parts of the ER8500C (Front Panel)

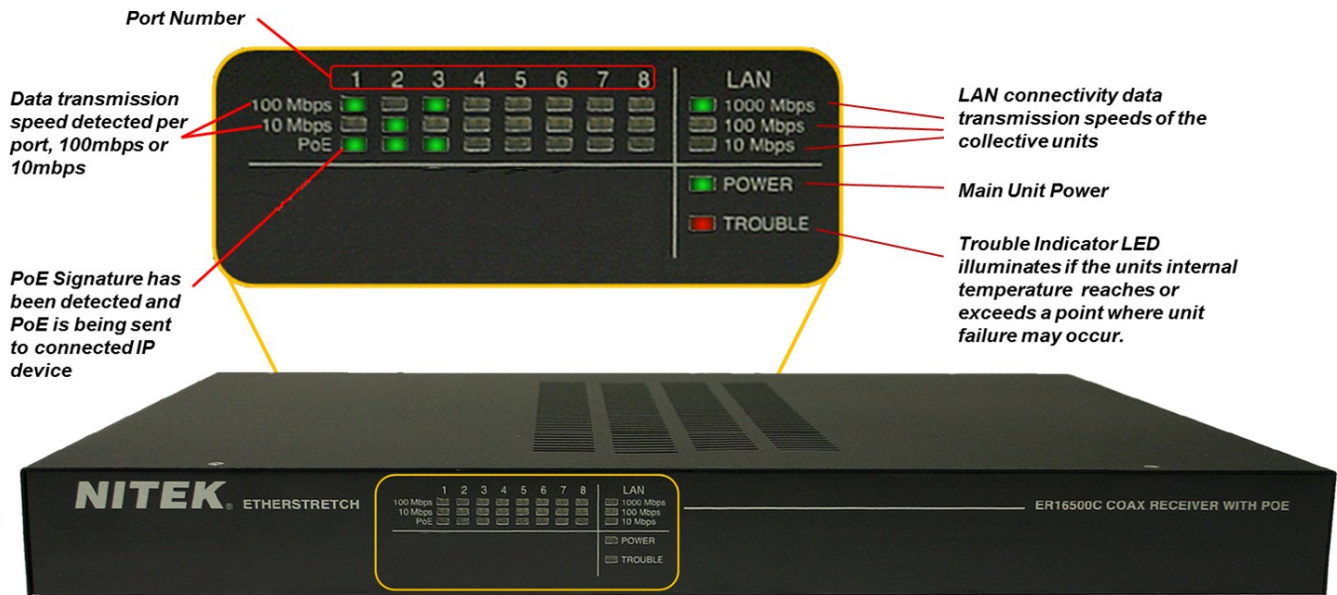

Installation & Setup

Installation Considerations

Wire and Cable Recommendations: The ER8500C is designed for use with up to eight (8)RG59U 75 Ohm copper based 18AWG (American Wire Gauge) coaxial cables. The quality of which must be consistent with any reasonably serviceable cable condition. That is free from damage as in cuts, breaks, or cracks to the outer covering and insulated shieldings which may compromise the signal conductivity of the cable(s).

For more specific information regarding wire types, gauges, and proper installation techniques please call Tech Support at 1-(800)528-4343.

Ethernet & PoE: The ER8500C is designed to receive up to 100Mbps (per port) of Ethernet TCP/IP data and transmit up to 1 Gigabit of aggregate LAN traffic. Additionally, the ER8500C provides per port sourcing PoE to operate itself, the transmitters (ET1500Cs), and all attached network devices (up to 8) while supporting 15.4W (802.3af) to 25.5W (802.3at) powering schemes at a maximum distance of 1,640ft./500m. Before considering this solution be sure that the cable(s) involved do not exceed the recommended maximum lengths. If the cable value is indeterminate at the time of installation, we recommend the use of a 3rd party time domain reflectometer (TDR) which through the use of short rise time pulses can measure impedance characteristics, splices, and unknown cable distance estimates.

Parts of the ER8500C (Rear Panel)

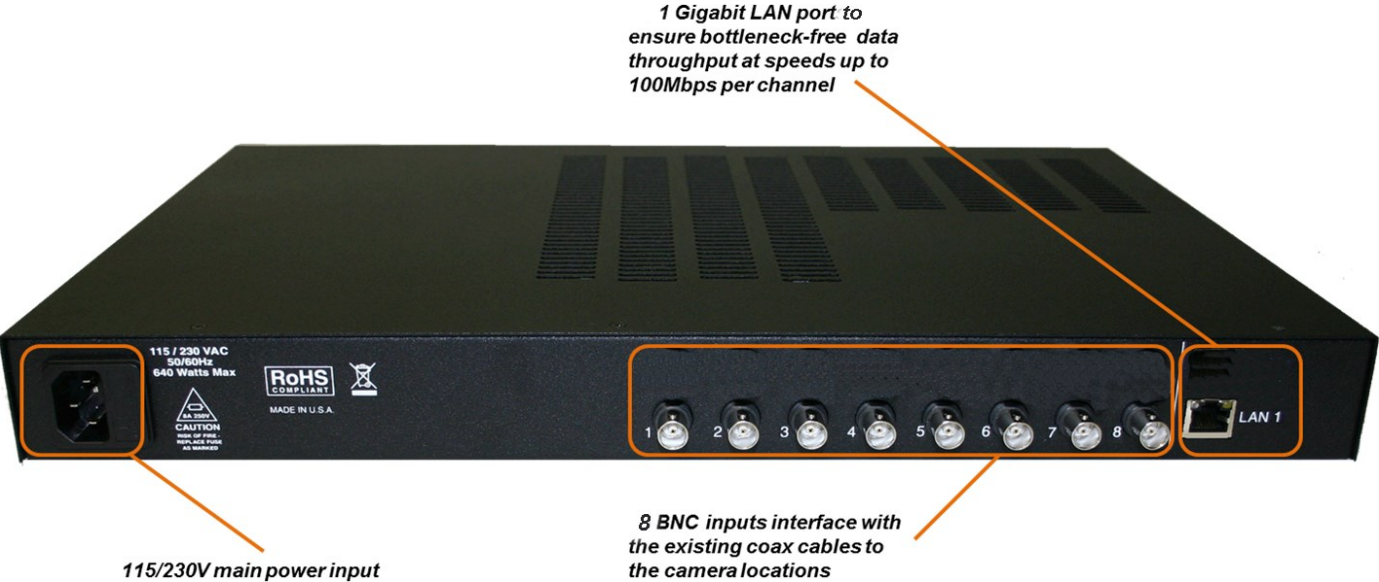

Device Mounting Options

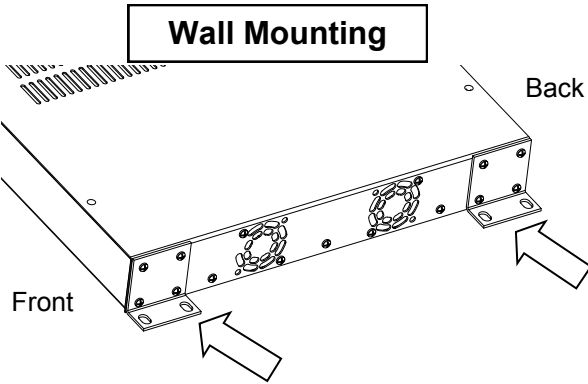
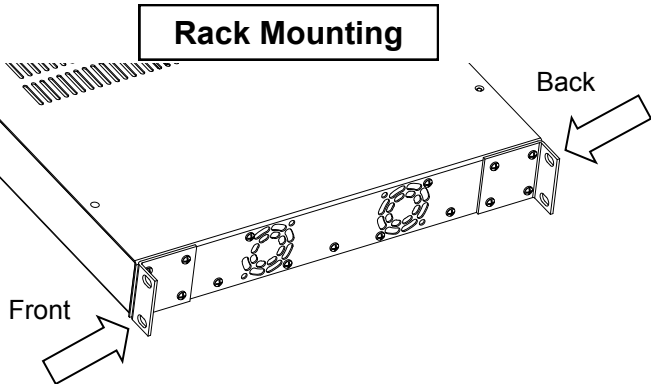

Installation & Setup

Equipment Requirements & Mounting: The process for employing the ER8500C is rather quick and simple. A common topology involves up to eight (8) existing coax cables (up to but not exceeding 1,640ft/500m), up to eight (8) ET1500C transmitters, up to eight (8) IP cameras or other peripheral network devices (both universally referred to as the Power Device(s) or PDs), the rack mounted ER8500C (which can be referred to as the NITEK Power Sourcing Equipment/PSE). The ER8500C NITEK PSE is both 802.3af and 802.3at compliant. That is it produces 15.4 W 48VDC @ 350mA of 802.3af as well as 25.5W 60VDC @ 600mA of 802.3at PoE+ power for proper attached device operation. Additionally, all RJ45 terminations are in accordance with 568B pinout standards.

The method for facilitating Ethernet communication and PoE flow over RG59U cable starts with connecting the ER8500C NITEK PSE to a series of up to eight (8) coax cables via the coax BNC connectors. The coax cables interface with the PDs via the ET1500C (up to 8) transmitters. The IP camera (s)/ PDs establish connectivity to ET1500Cs via RJ5 jacks and a CAT5e/CAT6 patch cords. The ER8500C powers itself and all attached devices within in this network/system. The IP data from the PDs is transmitted over each individual coax cable(s) through the ET1500C(s) to the rack mounted ER8500C in either the IDF or MDF. The aggregate PD data is transmitted to the greater LAN or WAN via the 1 gigabit LAN port located at the rear of the NITEK PSE to ensure congestion-free throughput. An illustration of this is represented below in the "Installment Topology" diagram.

Upon final termination the devices will undergo initialization and auto-configuration processes (see LED Indicator chart on pg.#7) which may take a number of seconds (time variations are device/installation/topology parameter dependent) to complete before PoE and Ethernet communication commences. For optimal performance referring to the PoE/distance chart (see pg.#6) and adhering to the IP camera/PD operational specifications is recommended. If issues arise during the installation process please see the "Trouble Shooting Tips" section (pg # 7). You may also contact our web based live tech support at: www.nitek.net or call 1-(800)528-4343 in order to speak with one of our engineers directly.

Installment Topology

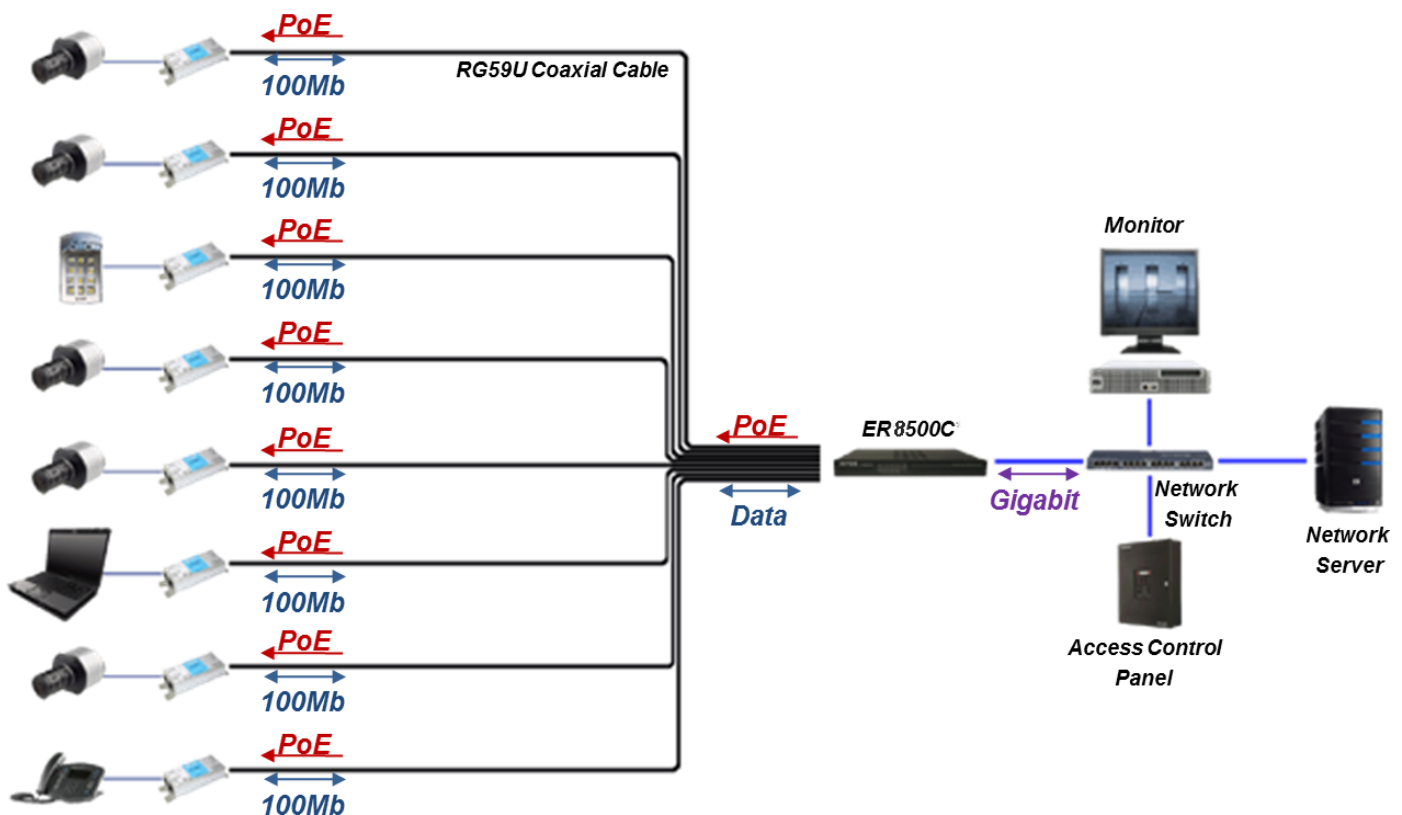

Unit Dimensions

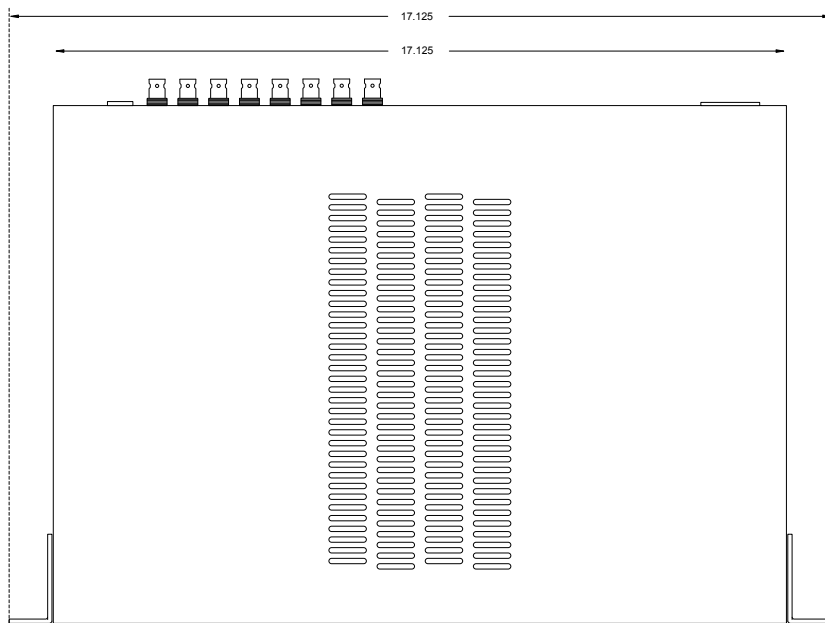

Top View

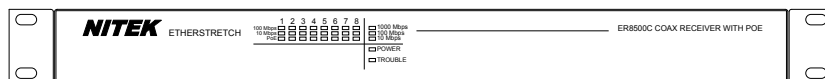

Front View

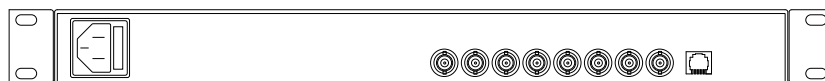

Rear View

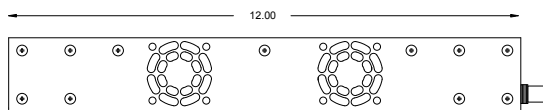

Left Side

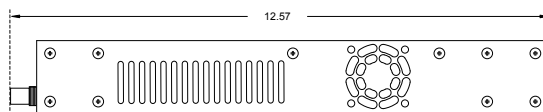

Right Side

568B Pinout Termination

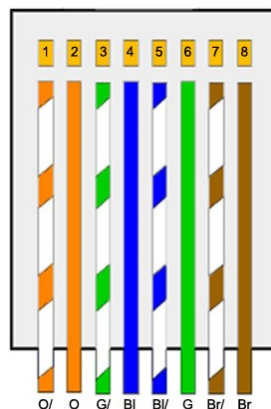
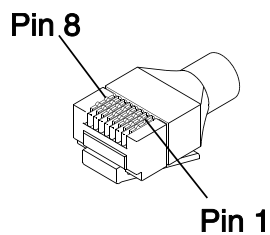

568B

Connectivity LED Status*

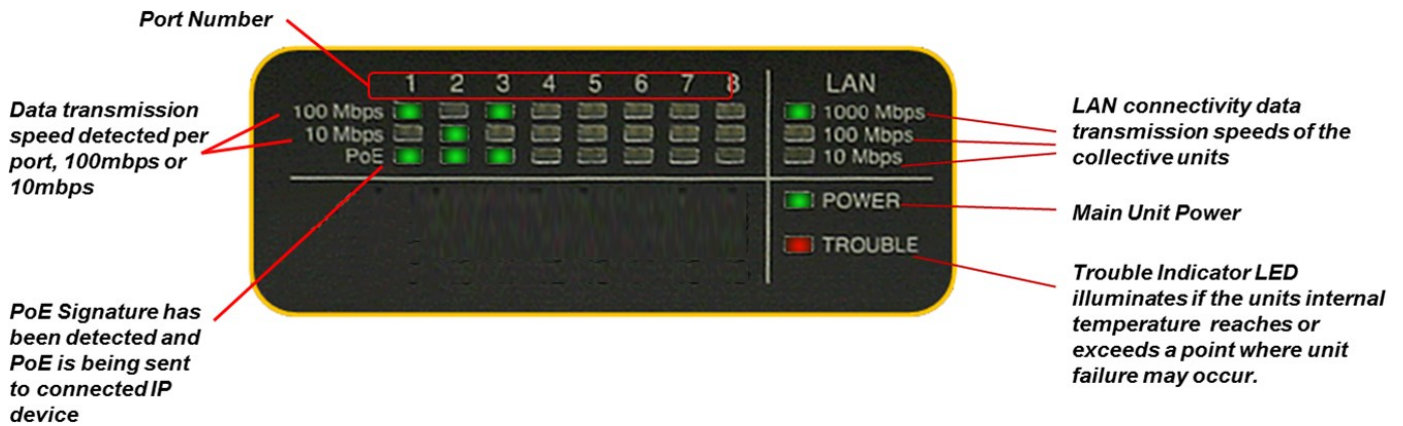

PoE Distance Chart

Available PoE Wattage At PoE Device

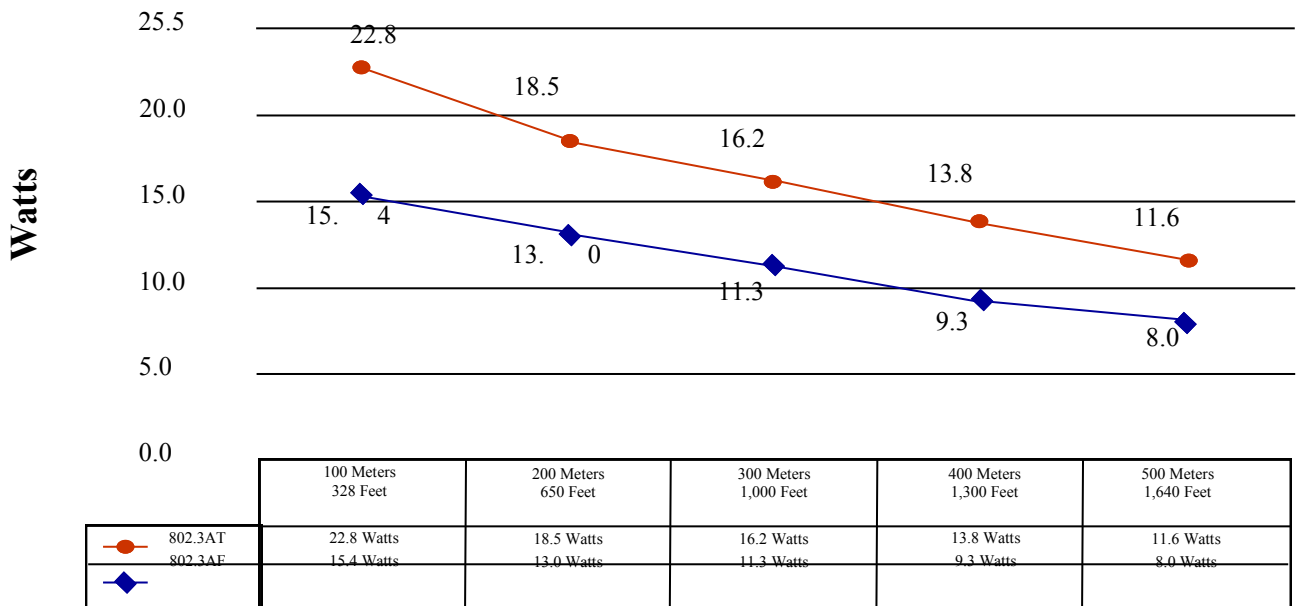

* Results charted were calculated using RG59U coaxial cable with a 20AWG center conductor and power sourcing equipment using IEEE 802.3AF standard with starting voltage of 48 volts DC and IEEE 802.3AT standard with starting voltage of 54 volts DC

Troubleshooting

PROBLEM	POSSIBLE CAUSE
No video/data	<p>Check camera and ER8500C/ET1500C(W)device connections.</p> <p>Check coax cable condition and BNC connectors.</p> <p>Check that the camera is powered.</p> <p>Check that supplied camera power meets manufacturer's specifications.</p> <p>Check cable that cable distances do not exceed PoE capabilities. Refer to chart on pg# 7.</p> <p>Check that coax cable length does not exceed the Ethernet data transmission operating distances of the ER8500C & ET1500C (W).</p> <p>Check link & device status. See chart on pg# 7.</p>
Video/data loss	<p>Check network switch terminations & link status.</p> <p>Check network routing table(s).</p> <p>Confer with site Network Administrator</p>

Technical Specifications

Receiver Unit

Network Output (LAN) Port	1x RJ45 Connector @ 1 Gigabit
Link Port	8x BNC Coax Jacks
Ethernet	100BASE-TX Full Duplex per BNC Jack
LED Connectivity Indicators	Link Status, Power, PoE Out, 10Mb or 100mb
Device Dimensions	1 RU x 12.0"D
Mounting	Standard rack mounting design
Operating Temperature	0° to 37° C / 32° to 98.6° F
Humidity	Up to 85% non-condensing
Power Requirements	IEC380 power connector/cord (included) - 115 VAC @ 60HZ
Total Power Output	640 Watts
PoE Capabilities	IEEE 802.3af & IEEE 802.3at compliance per BNC Jack
Max Operating Distance	1,640ft/500m
Shipping Weight	10 lbs

ER8500C 8 Port IP Video Extender Over Coax With Built-In Gigabit PoE Switch

*EtherStretch*TM



Product Warranty and Return Information

Lifetime Limited Warranty Network Extender Products

NITEK warrants the original consumer purchaser that the Network Extender products that it sells will be free from defects in material and workmanship. If any such product proves defective by our inspection, after sale to the original consumer purchaser, NITEK, at its option, will either repair the defective product without charge for parts and labor or will provide a replacement in exchange for the defective product.

In order to obtain service under this warranty, the customer must notify NITEK of the defect and shall be responsible for packaging and shipping the defective product to the service location designated by NITEK with shipping charges prepaid. NITEK shall pay for the return of the product to the purchaser if the shipment is to a location within the U.S.A. The purchaser shall be responsible for paying all shipping charges, duties and taxes if the product is returned from a location outside the U.S.A.

This warranty shall not apply to any defect, failure or damage caused by improper use or improper or inadequate maintenance or care, or to any product which shall have been repaired or altered outside our plant in any way, or which has been operated in a manner exceeding its specifications, or which has had the serial number removed. NITEK shall not be obligated to furnish service under this warranty: a) to repair damage resulting from attempts by personnel other than NITEK representatives to repair or service the product; b) to repair damage resulting from improper use or connection to incompatible equipment; or c) to service a product that has been modified or integrated with other products when the effect of such modification or integration increases the time or difficulty of servicing the product.

This warranty is given by NITEK with respect to the Network Extender products in lieu of any other warranties, express or implied. NITEK disclaims any implied warranties of merchantability or fitness for a particular purpose. NITEK's responsibility to repair or replace a defective product is the sole exclusive remedy provided to the purchaser for breach of this warranty. NITEK will not be liable for any indirect, incidental or consequential damages irrespective of whether NITEK has advance notice of the possibility of such damages.

Return Policy

- A. All returns for warranty, repair, credit or any other reason must be pre-authorized. A return merchandise authorization (RMA) form must be requested from the NITEK Customer Service Department. The form, which will be emailed to the customer, must be filled out completely and emailed back to the sender at NITEK for approval. An RMA number will be assigned if the request is approved. In any event, the customer will be notified by NITEK customer service of the outcome. All approved returns must be shipped freight prepaid, insured and properly packaged. A copy of the approved RMA form must be enclosed in the shipping container with the goods being returned and the RMA number must be marked in a visible area on the exterior of the container.
- B. Credit Returns must have been purchased within the last 30 days of the date of the receipt of the equipment at NITEK. Credit returns must be current products listed on the NITEK published price list, in effect at the time of the return and must be in new and saleable condition, with all factory packaging. All Credit returns are subject to a restocking charge of up to 40%. Additional restocking and/or refurbishing charges may be assessed upon inspection. If it is determined by NITEK that the returned equipment does not meet these conditions, a credit will not be issued.