

INSTALLATION GUIDE

EL1500U

IP Video Camera Over UTP Ethernet Extender & PoE Injector with EtherStretch



Description

The **EL1500U** is another component of the NITEK **EtherStretch** line. This Environmentally Hardened **EtherStretch** solution allows for the utilization of existing cable infrastructure (coax or UTP) to transmit data from IP cameras and other network devices along with power (PoE) to operate these networked devices well beyond standard network limitations. The system can extend Ethernet to over 600m or 1968ft of UTP cable making the **EL1500U** is ideal for retrofitting existing installations.

The EL1500U system consists of a transmitter and a receiver unit that require very little installation time and absolutely no set up or configuration. The system allow CAT5e and CAT6 cables to be used well beyond traditional limits. The EL1500U can communicate at 100Mb to distances over 600m or 1968ft. It can also turn these cables into PoE pathway to power and operate IP cameras.

The EL1500U is completely transparent to the network thus requiring no IP and MAC addressing. Simply connect your network devices to the networking ports of the transmitter and receiver along with existing cabling and the system begins communicating. LED indicators show the status and speed of network communications and PoE power.

The NITEK **EtherStretch** EL1500U reliably extends network communications to overcome cable distance limitations offering connectivity to devices in locations traditional networking does not allow. The units are constructed of industrial grade RoHS compliant plated aluminum with a corrosion resistant finish making them extremely durable.

Patent Pending



08172014

IEC/UL 60950-1

NITEK®

USA

5410 Newport Drive, # 24
Rolling Meadows, IL 60008
Phone: (847) 259-8900
Fax: (847) 259-1300
E-mail: info@nitek.net
WWW.NITEK.NET

EUROPE

De Aar 99
8253 PN Dronten
The Netherlands
Tel: +31(0) 321 310 043
E-mail: info@nitekeurope.net
WWW.NITEK.NET

Important Safety Instructions

Read all Safety Instructions.

Keep the Instructions for future reference.

Be sure to HEED all Warnings.

Follow ALL instructions.

DO NOT use this device or any of the equipment described, near water.

Clean this device ONLY with a dry cloth.

DO NOT block any ventilation openings.

Install in accordance with the manufacturer's instructions.

DO NOT install near any heat sources such as radiators, heat registers, stoves or other apparatus (including amplifiers) that produce heat.

DO NOT defeat the safety purposes of polarized or grounding type plugs. A polarized plug has two blades, with one blade wider than the other. A grounding plug has two blades and has a third grounding prong. The wide blade and the grounding prong are provided for your safety. If the provided plug does not fit into your outlet, consult an electrician for replacement of the obsolete outlet.

DO NOT connect the unit to an electrical supply if the wiring or over current protection of the supply could be overloaded when the ratings listed on the unit are considered.

Protect the power cord from being walked on or pinched especially at plugs, convenience receptacles and other points where they exit from the device.

Only use attachments and/or accessories specified by the manufacturer.

Refer all servicing to qualified service personnel. Servicing is required when the device has been damaged in any way, such as the power supply cord or plug is damaged, liquid has been spilled on, or objects have fallen into the device, the device has been exposed to rain or moisture, does not operate normally or has been dropped.

WARNING: To reduce risk of fire or electric shock, do not expose this apparatus to rain or moisture.

Installation shall be performed ONLY by qualified personnel and must conform to all local codes.

Unless the device is specifically marked as a NEMA 3, 3R, 3S, 4, 4X, 6 or 6P enclosure, it is designed for indoor use ONLY and it must not be installed where exposed to rain or moisture.

Parts of the EL1500U

LINK PORT SIDE

Link Status LED Indicator

- On Solid = Ethernet Link
- Off = No Ethernet Link

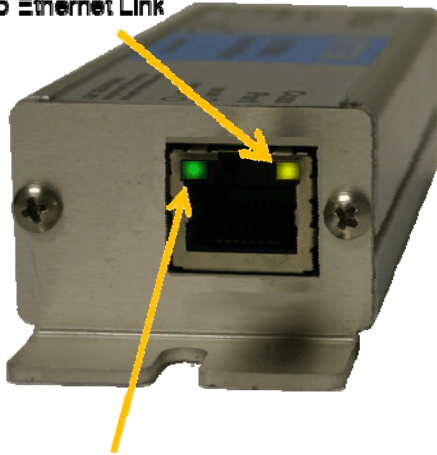

Power LED Indicator

- On Solid = The unit is powered and ready to use
- Off = The unit is not receiving power

NETWORK PORT SIDE

Link Status LED Indicator

- On Solid = Ethernet Link
- Off = No Ethernet Link

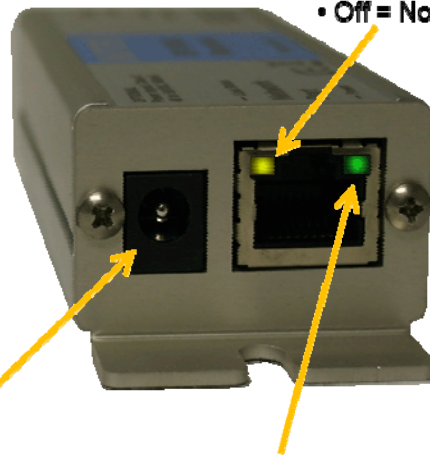

Optional Power Input

- Class 48-56VDC input to create PoE in installations where a PoE switch is not available.

Power LED Indicator

- On Solid = The unit is powered and ready to use
- Off = The unit is not receiving power

Installation Considerations

Wire and Cable Recommendations: The EL1500CW is designed to use with ANSI/TIA/EIA defined CAT5e or CAT6 Unshielded Twisted Pair (UTP) cabling. This UTP cable shall be able to accommodate TCP/IP data operating speeds of 10/100 Mbps transmission rates. The RJ45 termination pin out schemes shall be in accordance with the 568B standard. The quality of which must be consistent with any reasonably serviceable cable condition. That is free from damage as in cuts, breaks, or cracks to the outer covering and insulated shielding which may compromise the signal conductivity of the cable.

For more specific information regarding wire types, gauges, and proper installation techniques please call Tech Support at (800) 528-4343.

Ethernet & PoE: The EL1500U is designed to transmit and receive up to 100Mbps of Ethernet data and PoE from 15.4W (802.3af) to 25.5W (802.3at) at a maximum distance of 1968ft./600m. Before considering this solution be sure that the cable involved do not exceed the recommended maximum lengths. If the cable value is indeterminate at the time of installation, we recommend the use of a Time Domain Reflectometer (TDR) which through the use of short rise time pulses can measure impedance characteristics, splices, and unknown cable distance estimates.

Installation & Setup

Equipment Requirements & Mounting: The process for utilizing the EL1500U is rather quick and easy. A common topology involves a length of existing UTP cable (up to but not exceeding 1968ft/600m), the EL1500U transmitter and receiver pairs (ET1500U & ER1500U), an IP camera or other peripheral network device (both universally referred to as the Power Device or PD), and a 3rd party PoE network switch (or Power Sourcing Equipment/PSE). The PD and PSE must both be either 802.3af or 802.3at compliant. That is requiring or producing no more than 15.4 W 48VDC @ 350mA of 802.3af power up to 25.5W 60VDC @ 600mA of 802.3at PoE+ power for proper attached device operation. Additionally, all RJ45 terminations are in accordance with 568B pin out standards.

The method for facilitating Ethernet communication and PoE flow over the UTP cable starts with connecting the ER1500U to the PSE (RJ45-to-RJ45) via a CAT5e/CAT6 patch cable. The ER1500U's "Link Port" RJ45 enables connectivity to the length of CAT5e/CAT6 UTP cable. The IP camera/PD interfaces with the ET1500U via "Network Port" labeled RJ5 by a CAT5e/CAT6 patch cord. The output of the ET1500U intern connects to the length of CAT5e/CAT6 cable by its "Link Port" labeled RJ45 connector. Additionally, "PoE out" as indicated on the devices further discerns the proper direction of power & TCP/IP data flow. Power from the Power Sourcing Equipment provides operational PoE for both EL1500U units and attached the camera. An illustration of this is represented below in the "Installment Topology - Type A" diagram.

Upon final termination the devices will undergo initialization and auto-configuration processes (see LED Indicator chart on pg 7) which may take a number of seconds (time variations are device/installation/topology parameter dependent) to complete before PoE and Ethernet communication commences. For optimal performance referring to the PoE/distance chart (see pg 7) and adhering to the IP camera/PD operational specifications is recommended. If issues arise during the installation process please see the "Trouble Shooting Tips" section (pg 8). You may also contact our web based live tech support at: www.nitek.net/index.htm or call (800) 528-4343 in order to speak with one of our engineers directly.

Installment Topology - Type A

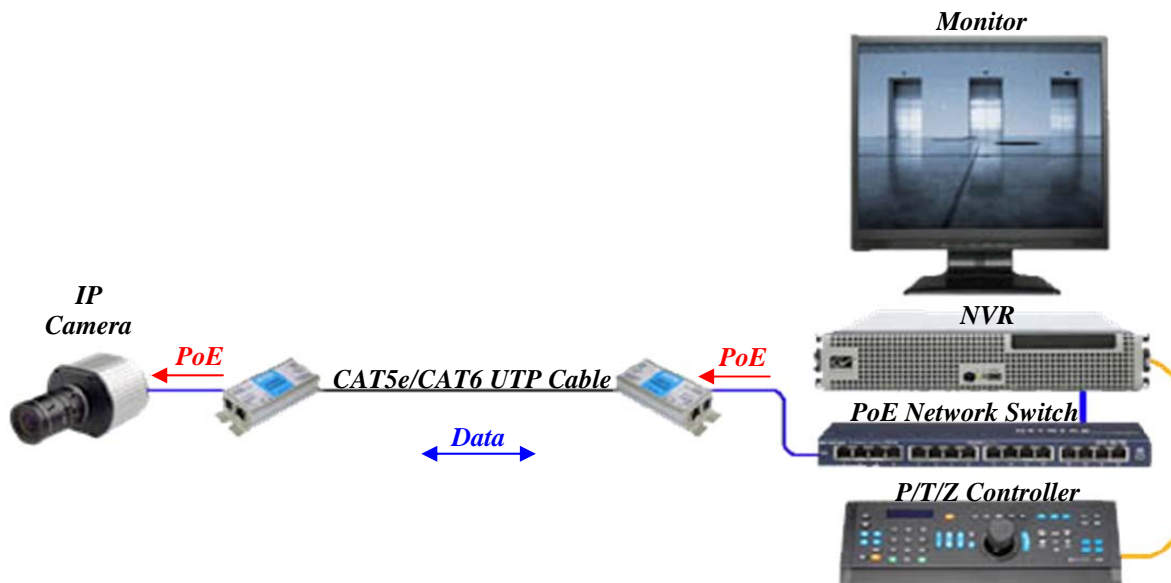

Shown in the diagram above, are two EL1500U devices (sold as a packaged pair) consisting of a transmitter and receiver unit. They are connected to a length of CAT5e/CAT6 UTP cable which enables the transmission of up to 100Mbps of network data. Power for the units as well as for the camera is derived from the 3rd party PoE network switch. Total operating distance of UTP cable between the EL1500U devices cannot exceed 1968ft/600m.

Installation & Setup

Equipment Requirements & Mounting: The process for utilizing the EL1500U is rather quick and easy. A common topology involves a length of existing UTP (CAT5e/CAT6) cable (up to but not exceeding 1968ft/600m), the EL1500U transmitter and receiver pairs (ET1500U & ER1500U), an IP camera or other peripheral network device (both universally referred to as the Power Device or PD), and a 3rd party PoE injector/inserter (or Power Sourcing Equipment/PSE). The camera and PSE must both be either 802.3af or 802.3at compliant. That is requiring or producing no more than 15.4 W 48VDC @ 350mA of 802.3af power up to 25.5W 60VDC @ 600mA of 802.3at PoE+ power for proper attached device operation. Additionally, all RJ45 terminations are in accordance with 568B pin out standards.

The method for facilitating Ethernet communication and PoE over the UTP cable starts with connecting the ER1500U “Network Port” labeled RJ45 to the NITEK or 3rd party PoE injector/inserter or Power Sourcing Equipment via a CAT5e/CAT6 patch cable. The ER1500U “Link Port” RJ45 enables connectivity to the length of CAT5e/CAT6 UTP “Link” cable. The IP camera interfaces with the ET1500U “Network Port” labeled RJ45 by a CAT5e/CAT6 patch cord. The output of the ET1500U intern connects to the length of CAT5e/CAT6 “Link” cable by its “Link Port” labeled RJ45 connector. Additionally, “PoE Out” as indicated on the devices further discerns the proper direction of power & data flow to the network switch. Power (PoE) from the Power Sourcing Equipment provides operational PoE for both the ET1500U and ER1500U units as well as for the attached the camera. An illustration of this is represented below in the “Installment Topology - Type B” diagram.

Upon final termination the devices will undergo initialization and auto-configuration processes (see LED Indicator chart on pg 7) which may take a number of seconds (time variations are device/installation/topology parameter dependent) to complete before PoE and Ethernet communication commences. For optimal performance referring to the PoE/distance chart (see pg 7) and adhering to the IP camera/PD operational specifications is recommended. If issues arise during the installation process please see the “Trouble Shooting Tips” section (pg 8). You may also contact our web based live tech support at: www.nitek.net/index.htm or call (800) 528-4343 in order to speak with one of our engineers directly.

Installment Topology - Type B

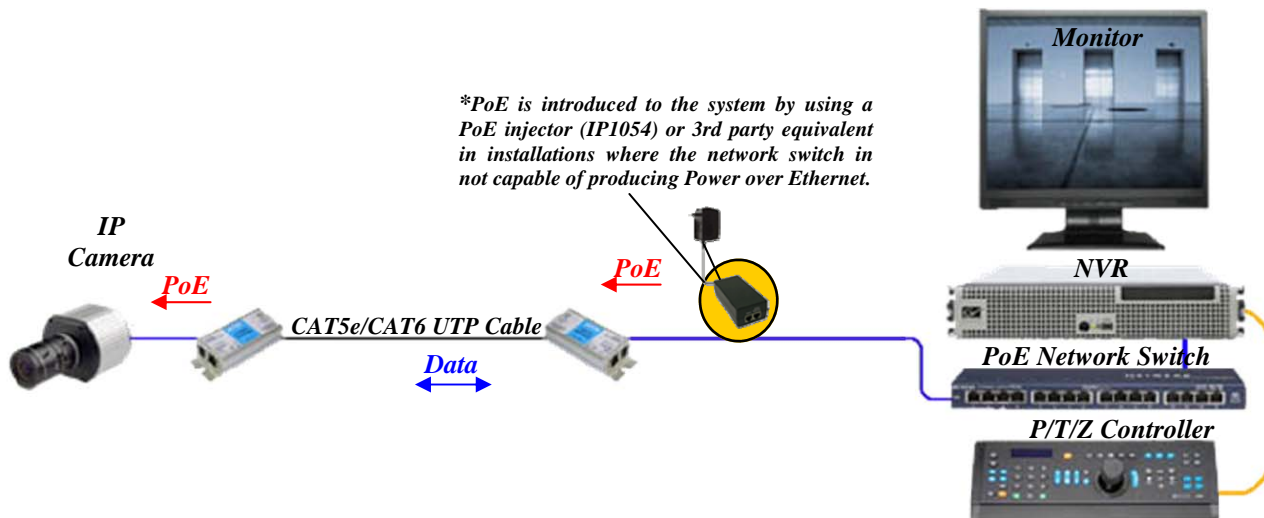

Shown in the diagram above, are two EL1500U devices (sold as a packaged pair) consisting of a transmitter and receiver unit. They are connected to a length of CAT5e/CAT6 cable which enables the transmission of up to 100Mbps of network data. Power for the units as well as for the IP camera is derived from the 3rd party PoE Injector/Inserter. Total distance, via UTP cable, between the EL1500C devices cannot exceed 1968ft/600m.

Device Dimensions

Link Port View

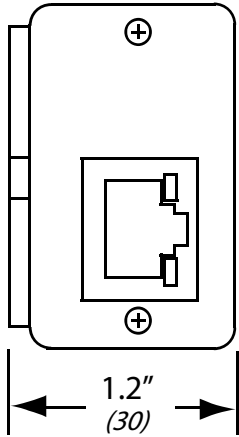

IP Port View

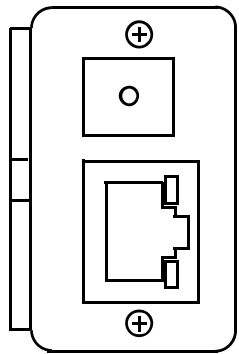

Top View

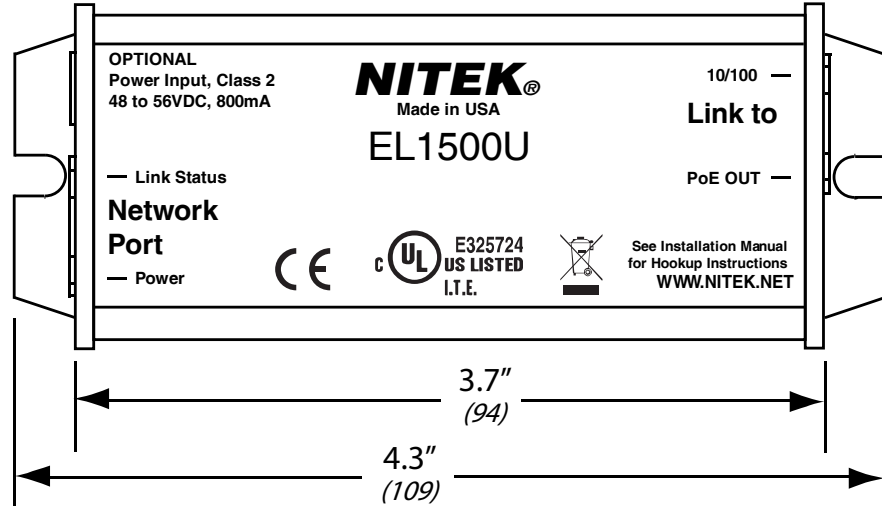

Bottom View

568B Pin out Termination

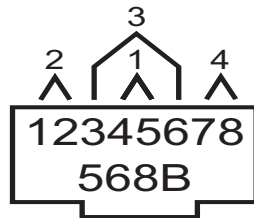
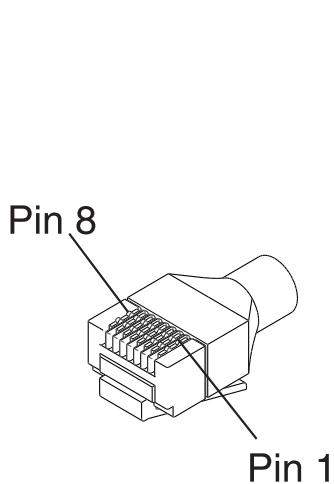

PIN	COLOR
1	WHT/ORG
2	ORG/WHT
3	WHT/GRN
4	BLU/WHT
5	WHT/BLU
6	GRN/WHT
7	WHT/BRN
8	BRN/WHT

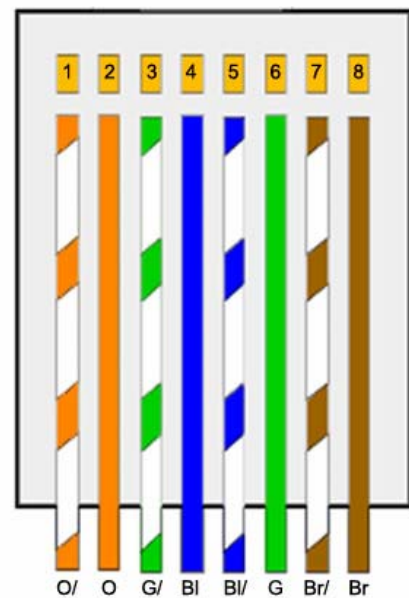

568B

Connectivity Status

LINK PORT

Link Status LED Indicator

- On Solid = Ethernet Link
- Off = No Ethernet Link

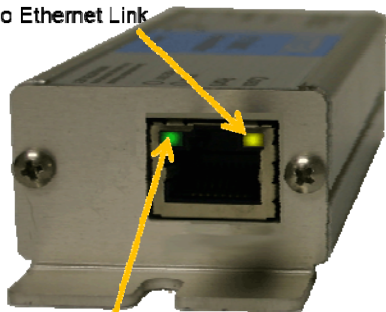

Power LED Indicator

- On Solid = The unit is powered and ready to use
- Off = The unit is not receiving power

NETWORK PORT

Link Status LED Indicator

- On Solid = Ethernet Link
- Off = No Ethernet Link

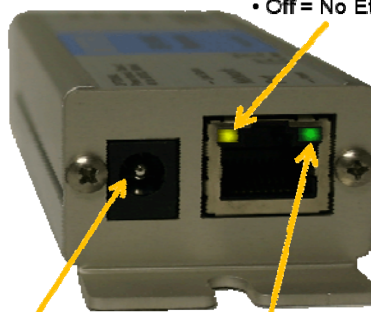

Power LED Indicator

- On Solid = The unit is powered and ready to use
- Off = The unit is not receiving power

Optional Power Input

- Class 48-56VDC input to create PoE in installations where a PoE switch is not available.

LED INDICATORS				
Connector	LED	OFF	ON	FLASHING
Network Port	Power	No power	Power Good	
	Link Status	No Ethernet Link	Ethernet Link Good	
Link Port	PoE Out	No PoE Power Out	PoE Power Good	
	10/100	No Link	100Mb	10Mb

PoE Distance Chart

Available PoE Wattage At PoE Device

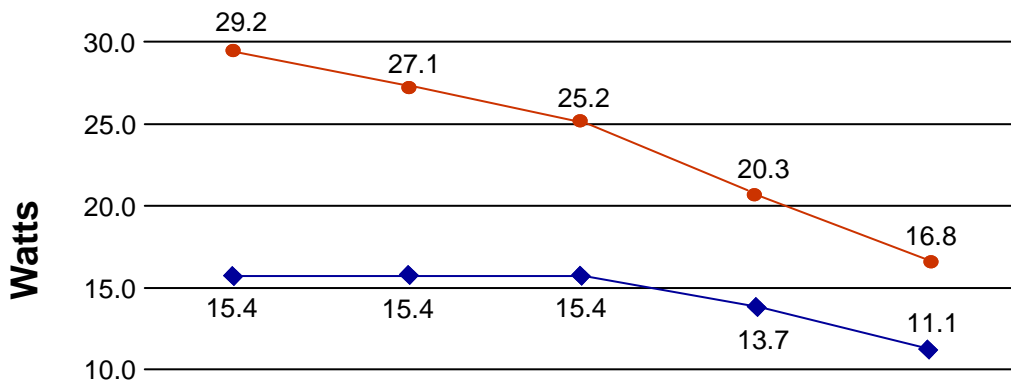

	100 Meters 328 Feet	200 Meters 656 Feet	300 Meters 984 Feet	400 Meters 1,312 Feet	500 Meters 1,640 Feet
802.3AT	29.2 Watts	27.1 Watts	25.2 Watts	20.3 Watts	16.8 Watts
802.3AF	15.4 Watts	15.4 Watts	15.4 Watts	13.7 Watts	11.1 Watts

* Results charted were calculated using four pair 24awg Cat5e cabling and power sourcing equipment using IEEE 802.3AF standard with starting voltage of 48 volts DC and IEEE 802.3AT standard with starting voltage of 54 volts DC

Troubleshooting

PROBLEM	POSSIBLE CAUSE
No video/data	<p>Check camera and EL1500U device connections. Check UTP cable condition and RJ45 connectors. Check that the camera is powered. Check that supplied camera power meets manufacturer's specifications. Check that UTP cable distances does not exceed PoE capabilities. Refer to chart on pg 7. Check that UTP cable does not exceed EL1500U operating distances. Check link & device status. See chart on pg 7.</p>
Video/data loss	<p>Check network switch termination(s) & link status. Check network routing table(s). Confer with site Network Administrator</p>

For Tech Support Call **(800)528-4343**

Technical Specifications

Network Transmission Device

Network Port	RJ45 Jack
Link Port	RJ45 Jack
Ethernet	[1] Auto Configuring 100BASE-TX Full Duplex
LED Indicators	Link Status, Power, PoE out, 10Mb or 100Mb
PoE Compliance	IEEE 802.3af & IEEE 802.3at
Max Operating Distance	1,968ft /600m
Max PoE Operating Distance(s)	See "PoE Distance Chart" on pg 7
Power Draw per Device	1.65 Watts each
Rating/Listing	
UL	IEC/UL 60950-1
NEMA TS-2	Temperature & Humidity NEMA 2.2.7 Mechanical Vibration NEMA 2.2.8 Mechanical Shock NEMA 2.2.9 Operating Voltage NEMA 2.1.2 Operating Frequency NEMA 2.1.3 Transient Test NEMA 2.1.6 thru 2.1
Operating Temperature	-40° to 75° C / -40° to 167° F
Humidity	Up to 95% non-condensing
Dimensions	1.2" x 1.7" x 4.3" (including mounting tabs)
Mounting	Two 3/8 inch mounting tab slots
Shipping Weight	2 lbs

Product Warranty and Return Information

Lifetime Limited Warranty Network Extender Products

Nitek warrants to the original End User of Etherstretch products hereunder will be free from defects in material and workmanship as of the date of shipment, and that said product will conform to Nitek published technical specifications as of said date. The foregoing shall apply only to failures to meet said warranties which appear within that period of time during which the Products are installed in their original installation for the original End User and operator of such Etherstretch Products; provided, however, that in the event of product discontinuance, warranty support is limited to five (5) years from the announcement of discontinuance. The duration of the warranty period for products not manufactured by Nitek (e.g., coaxial cabling, test equipment, power supplies or batteries) shall be the warranty period offered by the original manufacturer, if any.

The conditions of any tests shall be mutually agreed upon and Nitek shall be notified of the test, and has the right to be represented at any and all tests that may be made. The warranties and remedies set forth herein are conditioned upon proper storage, installation, use and maintenance, and conformance with any applicable recommendations of Nitek. Additionally, Buyer must promptly notifying Nitek of any defects and, if required, promptly making the product available for correction.

If any product fails to meet the foregoing warranties, Nitek shall correct any such failure either at its option, (a) by repairing any defective or damaged product or parts of the products, or (b) by making available any necessary repaired or replacement products or parts thereof. Any repaired or replacement part or product shall be warranted for the remaining period of the original Warranty Period. Nitek's liability with respect to any product shall not exceed a refund of the price received by Nitek for that product, and in no event shall Nitek have any liability for any incidental, consequential, special, or indirect damages.

To obtain warranty service, you must first call Nitek and speak to a qualified service representative. If a return of product is deemed necessary, a Return Authorization number (RA#) will be issued. Upon receiving a RA#, the product must be shipped back in either its original packaging or packaging providing an equal degree of protection. This warranty does not cover cosmetic damage or damage due to acts of God, accident, misuse, abuse, negligence, or modification of, or to any part of the Product. This warranty does not cover damage due to improper operation or maintenance, connection to improper voltage supply, or attempted repair by anyone other than a facility authorized by Nitek to service the product. Repair or replacement as provided under this warranty is the exclusive remedy of the consumer. This warranty only covers the first user of the equipment.

Return Policy

- A. All returns for warranty, repair, credit or any other reason must be pre-authorized. A return merchandise authorization (RMA) form must be requested from the NITEK Customer Service Department. The form, which will be emailed to the customer, must be filled out completely and emailed back to the sender at NITEK for approval. An RMA number will be assigned if the request is approved. In any event, the customer will be notified by NITEK customer service of the outcome. All approved returns must be shipped freight prepaid, insured and properly packaged. A copy of the approved RMA form must be enclosed in the shipping container with the goods being returned and the RMA number must be marked in a visible area on the exterior of the container.
- B. Credit Returns must have been purchased within the last 30 days of the date of the receipt of the equipment at NITEK. Credit returns must be current products listed on the NITEK published price list, in effect at the time of the return and must be in new and saleable condition, with all factory packaging. All Credit returns are subject to a restocking charge of up to 40%. Additional restocking and/or refurbishing charges may be assessed upon inspection. If it is determined by NITEK that the returned equipment does not meet these conditions, a credit will not be issued.